



Hurricane Case (507x386x190mm)

Part No: EN-EC-37-7

Made from high impact plastic with silicone foam seals, the Hurricane case is the ultimate protection for your valuable tools and equipment. Rated at IP67 the case is dust tight, air tight, chemical and corrosion resistant, and can withstand immersion in water up to 1 metre. Cases come with high density, pre-cubed foam layers for easy cutting of custom shapes.

- IP67 Rated - Watertight, Airtight and Dustproof.
- IK08 Rated - Shock and Crushproof.
- Pressure Equalization Valve - Adjust internal air pressure.
- Chemical Resistant and Anti-Corrosive - Handles almost any environment.
- High Density Cubed Foam Layers - Ultimate protection for your items.
- Able to withstand full immersion in water up to 1m for up to 30 minutes.
- Temperature Range from -20°C to 60°C (Short Term -40°C to 80°C).
- Secure Padlock Loops - Keep your items secure.



Colours Available

Hurricane Case Dimensions

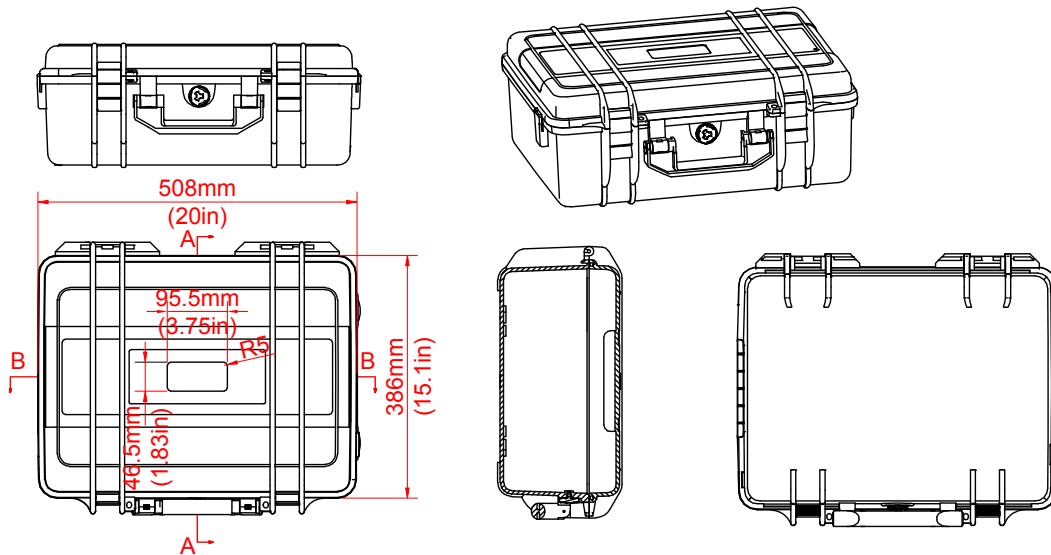

Top Dimensions

Base Dimensions

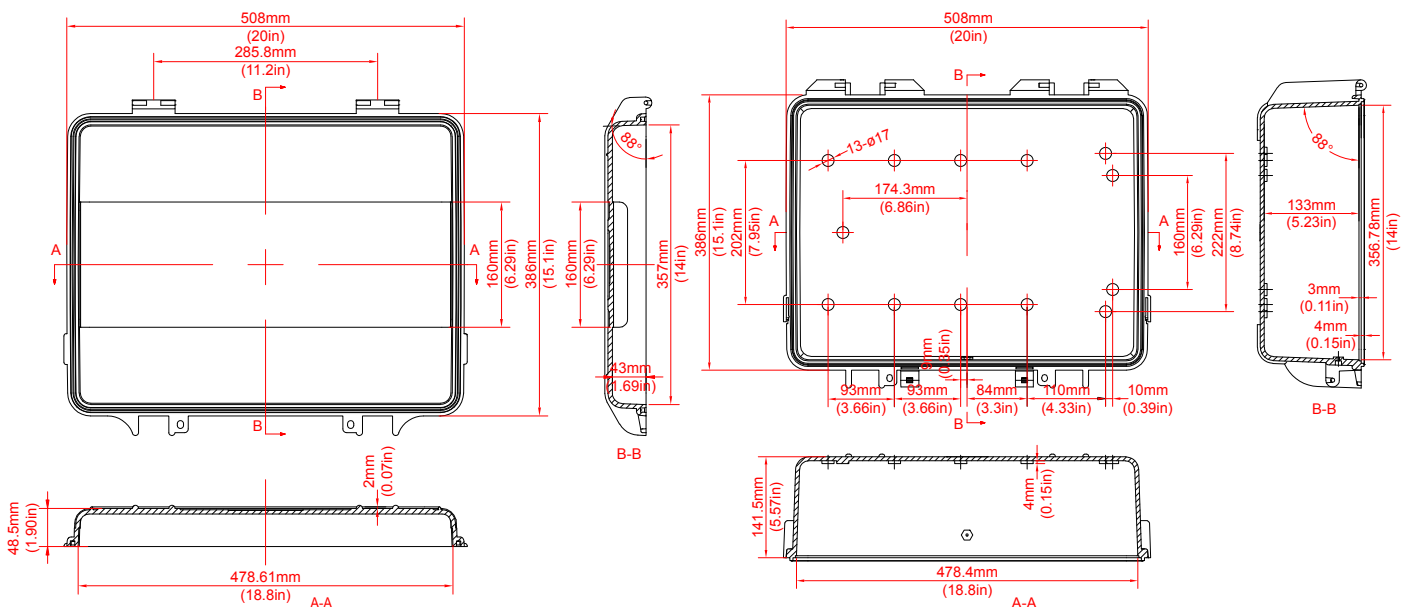

Hurricane Case (507x386x190mm)

cases-and-enclosures.co.uk
+44 (0)1992 455926

